

## DETAIL SPECIFICATION

## MODULE, STANDARD ELECTRONIC CONTROL

This specification is approved for use by all Departments and Agencies of the Department of Defense.

## 1. SCOPE

1.1 Scope. This specification covers the Module, Standard Electronic Control (MSEC), a component of Halon 1301 fire extinguishing systems used in military vehicles. The MSEC continuously monitors the system condition. Upon receipt of a fire signal, it issues crew warning and extinguisher discharge commands.

## 2. APPLICABLE DOCUMENTS

2.1 General. The documents listed in this section are specified in sections 3, 4, or 5 of this specification. This section does not include documents cited in other sections of this specification or recommended for additional information or as examples. While every effort has been made to ensure the completeness of this list, document users are cautioned that they must meet all specified requirements documents cited in sections 3, 4 and 5 of this specification, whether or not they are listed.

2.2 Government documents.

2.2.1 Specifications, standards, and handbooks. The following specifications, standards, and handbooks form a part of this document to the extent specified herein. Unless otherwise specified, the issues of these documents are those, cited in the solicitation or contract ([see 6.2](#)).

## COMMERCIAL ITEM DESCRIPTIONS

A-A-52557 - Fuel Oil, Diesel, for Posts, Camps, and Stations.

## DEPARTMENT OF DEFENSE SPECIFICATIONS

MIL-PRF-62546 - Sensor, Fire, Optical.  
MIL-DTL-62547 - Valve and Cylinder Assemblies, Halon 1301.

## DEPARTMENT OF DEFENSE STANDARDS

MIL-STD-130 - Identification Marking of U.S. Military Property.  
MIL-STD-171 - Finishing of Metal and Wood Surfaces.  
MIL-STD-461 - Requirements for the Control of Electromagnetic Interference, Characteristics of Subsystems and Equipment.  
MIL-STD-810 - Environmental Engineering Considerations and Laboratory Tests.  
MIL-STD-1275 - Characteristics of 28 Volt DC Electrical Systems in Military Vehicles.  
MS3114 - Connectors, Receptacle, Electrical, Series 1, Solder Type, Jam Nut Mounting, Bayonet Coupling, Classes E, F, H, and P (inactive for new design).

Comments, suggestions, or questions on the document should be addressed to Defense Supply Center Columbus, DSCC-VAT, P.O. Box 3990, Columbus, OH 43128-3990, or e-mailed to [TubesAmps@dsccl.dla.mil](mailto:TubesAmps@dsccl.dla.mil). Since contact information can change, you may want to verify the currency of this address information using the ASSIST Online database at <http://assist.daps.dla.mil>.

MIL-DTL-62545D

- MS3121 - Connectors, Plug, Electric, Crimp Type, Cable-Connecting, Bayonet Coupling (inactive for new design).
- MS3474 - Connectors, Receptacle, Electrical, Series II, Crimp Type, Rear Mounting Jam Nut, Bayonet Coupling, Classes A, L, and W.

(Copies of these documents are available online at <http://assist.daps.dla.mil/quicksearch/> or <http://assist.daps.dla.mil> or from the Standardization Document Order Desk, Building 4D, 700 Robbins Avenue, Philadelphia, PA 19111-5094.)

2.2.2 Other Government documents, drawings, and publications. The following other Government documents, drawings, and publications form a part of this document to the extent specified herein. Unless otherwise specified, the issues are those cited in the solicitation or contract.

DRAWINGS

ARMY (TACOM)

- 12343265 - Connector, Electrical Receptacle.
- 12370459 - Module, Standard Electronic Control.

PUBLICATIONS

TEST PROCEDURES (TACOM)

- Nuclear Survivability - Nuclear Survivability Criteria for the Automatic Fire Extinguishing System (AFES) (U). Document is classified "Confidential".

(Copies are available from Department of the Army, United States Army Tank-Automotive and Armaments Command, 6501 E. 11 Mile Road, Warren, Michigan 48397-5000.)

2.3 Non-Government publications. The following document(s) form a part of this document to the extent specified herein. Unless otherwise specified, the issues of documents are those cited in the solicitation or contract ([see 6.2](#)).

ASTM INTERNATIONAL (ASTM)

- ASTM-G21 - Determining Resistance of Synthetic Polymeric Materials to Fungi (DoD adopted).

(Copies of these documents are available online at <http://www.astm.org/> or from ASTM INTERNATIONAL, 100 Barr Harbor Drive, West Conshohocken, PA 19428-2959.)

2.4 Order of precedence. In the event of a conflict between the text of this document and the references cited herein, the text of this document takes precedence. Nothing in this document, however, supersedes applicable laws and regulations unless a specific exemption has been obtained.

3. REQUIREMENTS

3.1 First article inspection. MSEC's furnished under this specification shall be products which are capable of meeting all first article inspection requirements specified herein ([see 4.3](#)).

3.2 Materials. Materials used shall be as specified herein and as specified in referenced specifications, standards, and drawings. Materials shall be free of defects which adversely affect performance or serviceability of the finished product. Materials shall be suitable for use over an ambient temperature range from -51 to +71 degrees Celsius (°C) (-60 to +160 degrees Fahrenheit (°F)). There shall be no changes in physical or dimensional characteristics that could result in the operation of the MSEC falling outside the limits specified herein ([see 4.6.1](#)).

3.2.1 Dissimilar metals. Except where necessary to complete an electrical circuit, contact between dissimilar metals, which could encourage galvanic action, shall be avoided. Separation of dissimilar metals shall be accomplished by providing approved protective finishes, coatings, or insulation between the mating materials and shall be in accordance with provisions of MIL-STD-171 which address reduction of corrosion at intermetallic contact points. Corrosion-resistant materials shall be used whenever possible (see 4.6.1).

3.2.2 Encapsulation. Encapsulation (if used) shall be silicone rubber compound to permit removal for repair (see 4.6.1).

3.2.3 Recycled, recovered, or environmentally preferable materials. Recycled, recovered, or environmentally preferable materials should be used to the maximum extent possible provided that the material meets or exceeds the operational and maintenance requirements and promotes economically advantageous life cycle costs. All components supplied shall be new and unused.

3.2.4 Pure tin. The use of pure tin as an underplate or final finish is prohibited both internally and externally. Tin content of the standard electronic control module components and solder shall not exceed 97 percent, by mass. Tin shall be alloyed with a minimum of 3 percent lead, by mass (see 6.8).

3.3 Design and construction. The MSEC shall be designed to monitor and control fire extinguishing systems consisting of the following components:

- a. One MSEC.
- b. One to four Halon 1301 fire extinguishers in accordance with MIL-DTL-62547.
- c. One to four optical fire sensor assemblies (OFSA) in accordance with MIL-PRF-62546.
- d. Built-in-test-equipment (BITE) (integral with above components).
- e. Test and alarm panel.
- f. Interconnecting electrical harnesses.

The MSEC shall issue signals upon receipt of the following data:

- a. Report of system condition from the BITE.
- b. Report of extinguisher availability.
- c. A fire signal from an OFSA or from the test and alarm panel.

A large fire signal, which may originate from an OFSA or the test and alarm panel, shall cause the MSEC to drive extinguisher discharge, activate visible and audible fire warnings, and power a ventilation fan relay. In response to a small fire signal from an OFSA(s), the MSEC shall only activate warnings. Loss of continuity in extinguisher circuits shall cause the MSEC to activate extinguisher status lamps. The MSEC shall not be involved in OFSA decisions respecting the nature and origin of fires and false alarms. The MSEC shall communicate system condition between BITE and the test and alarm panel. Operating temperature range shall be -51 to +71°C (-60 to +160°F) (see 4.6.1).

3.3.1 Activation sequence. The MSEC shall monitor the availability of, and shall activate, extinguishers as specified herein. The order of priority of the extinguishers shall be 1 (highest), 2, 3, and 4. Extinguishers shall be considered available when pressure/flow switch and solenoid continuities are sensed by the MSEC (see 3.4.5 and table I). Within 2 milliseconds (ms) of receipt of a large fire signal from an OFSA or an electrical-manual activation signal, the MSEC shall apply extinguisher drive signals to the two highest priority available extinguishers. An extinguisher shall not be considered available for 8 to 10 second(s) after the MSEC has supplied a drive signal to it. If flow indications are not received within 38 ms of the start of the drive signal for either or both of the extinguishers chosen initially, the MSEC shall provide automatic back-up (see 6.4.3) to select and apply drive signals to the next highest priority extinguisher(s) and check its flow in turn. After the MSEC begins extinguisher activation, it shall ignore OFSA large fire signals for 0.5 second and electrical-manual activation signals for 4 to 6 seconds. If the

MIL-DTL-62545D

MSEC finds no available extinguishers at a time when a large fire signal is present, it shall sequentially apply an extinguisher drive signal to each extinguisher (with not more than 2 ms between consecutive drive signals). This is done on the possibility that extinguishers indicated as unavailable may, in fact, be usable. The MSEC shall not apply subsequent drive signals until extinguisher availability is again indicated (see figure 1 and 4.6.3).

TABLE I. Electrical signal characteristics. 1/ 2/

Symbol	Signal
A	<p style="text-align: center;"><u>Logic</u></p> 10 V dc to 30 V dc Source output impedance $\leq 2,000 \Omega$ 3/ Load input impedance $\geq 20,000 \Omega$ 4/ Quiescent conditions: 1 V dc maximum Input impedance (source and load) $\geq 20,000 \Omega$
B	<p style="text-align: center;"><u>Extinguisher drive</u></p> 16 V dc to 30 V dc 10 A minimum for load impedance $\leq 1.3 \Omega$ 20 A maximum Total load impedance: 0.5 to 2.3 $\Omega$ Quiescent condition: See signal C
C	<p style="text-align: center;"><u>Continuity monitoring</u></p> 5 mA maximum Source input and output impedance $\geq 20,000 \Omega$ Total load impedance: $\leq 2.3 \Omega$
D	<p style="text-align: center;"><u>Lamp drive</u></p> 16 V dc to 30 V dc Source input impedance $\geq 20,000 \Omega$ Load impedance $\geq 750 \Omega$ Quiescent condition: 1 V dc maximum Source input and output impedance $\geq 20,000 \Omega$

1/ All outputs shall be capable of withstanding short circuits of indefinite duration.

2/ Whenever a range of values is specified for an input signal or input duration, the component shall be capable of meeting all requirements at any point within the specified range.

3/ Less than or equal to ( $\leq$ ).

4/ Greater than or equal to ( $\geq$ ).

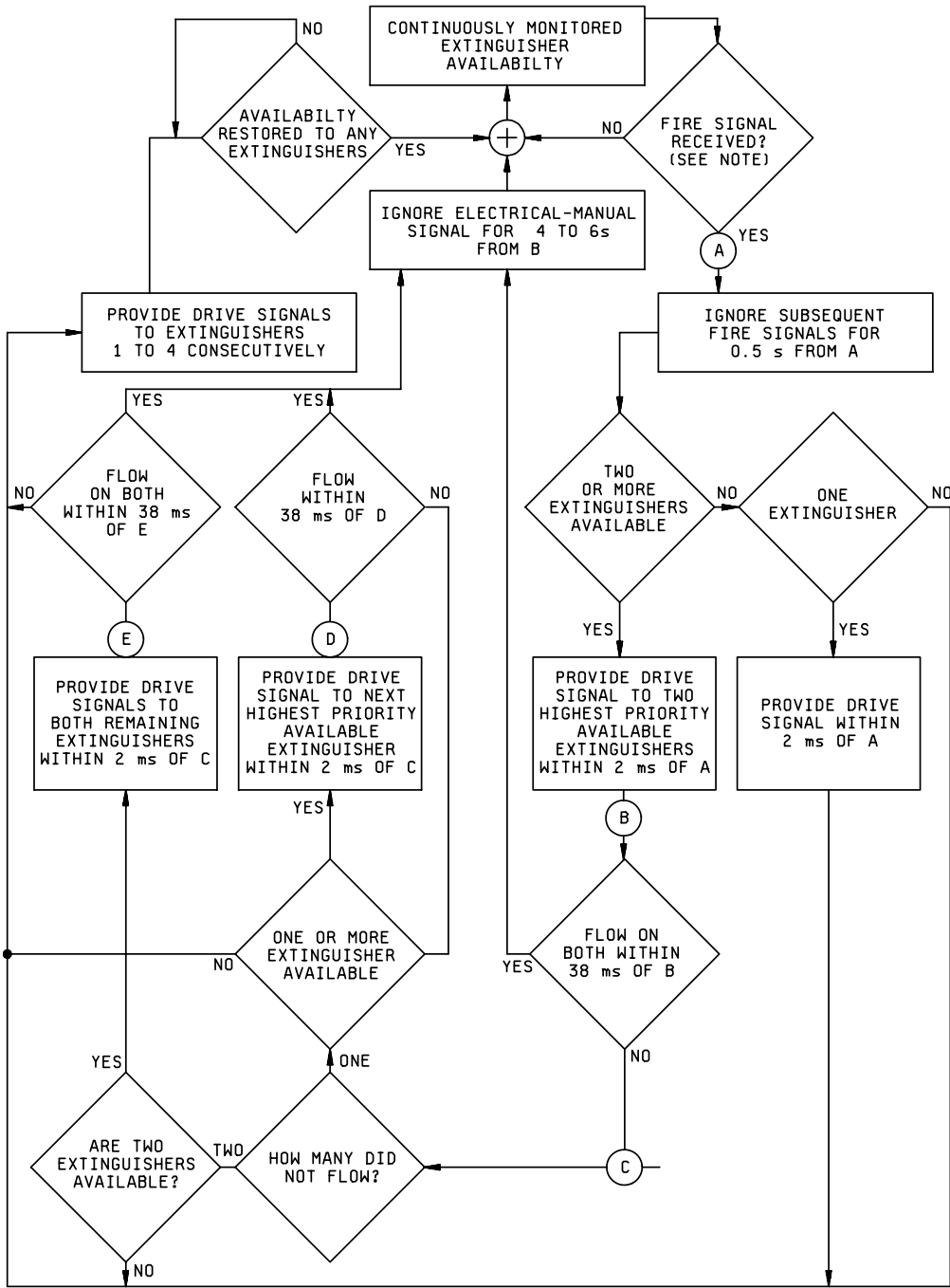

NOTE: Either a large fire signal from any OFSA(s) or an electrical-manual activation signal shall be considered a fire signal.

FIGURE 1. Extinguisher activation logic.

3.3.2 Warning signals. The MSEC shall provide fire warning signals for small and large fires as follows (see 4.6.3).

3.3.2.1 Fire signals. Upon receipt of a signal from the OFSA for a small threshold fire, the MSEC shall energize the fire warning lamp and an audible fire warning signal without activating the extinguisher drive signals. A large fire signal occurring while a small fire signal is present shall energize the fire warning lamp, the audible fire warning signal, and the appropriate extinguisher drive signals. The fire warning circuit shall not lock in the energized position (see table II) (see 4.6.3).

3.3.2.2 Extinguisher status. The MSEC shall energize four extinguisher status lamps, one for each extinguisher. These lamps, when energized, shall indicate a continuity break, low extinguisher pressure or that extinguishant flow has occurred. Continuity loss shall not render the remainder of the system inoperative (see table II and table III) (see 4.6.3).

3.3.3 BITE. The MSEC shall incorporate BITE capability which conducts to a total electronic check as specified in 3.4.6. A fault signal detected in an OFSA shall cause signals from that unit to be ignored, and the remainder of the system shall be operative (see 4.6.3).

3.3.4 Configuration. The MSEC shall conform physically and dimensionally to Drawing 12370459 (see 4.6.1 and 4.6.2).

3.3.5 Connector receptacles. The MSEC shall electrically interface with fire extinguishing systems through the connector receptacles called out on Drawing 12370459 and as specified below (note: MS3474, MS3121 and MS3114 are inactive for new design). The MSEC internal wiring to the connectors shall provide for its function in, and interface with, the vehicle and fire extinguishing system as follows (see 4.6.1, 4.6.2, and 4.6.3).

- a. MSEC connector J1: MS3474 W22-21PN, MS3121 W22-21PN, MS3114 W22-21PN or 12343265-2.
- b. MSEC connector J2: MS3474 W22-21SN, MS3121 W22-21SN, MS3114 W22-21SN or 12343265-3.
- c. MSEC connector J3: MS3474 W18-32SN, MS3121 W18-32SN, MS3114 W18-32SN or 12343265-4.

3.3.5.1 Receptacle J1. Receptacle J1 shall communicate with the test and alarm panel, vehicle power, the fire warnings, and the ventilation fan. It shall be wired for the signal assignments shown in table II (see 4.6.3).

3.3.5.2 Receptacle J2. Receptacle J2 shall communicate with the extinguishers. Receptacle J2 wiring shall be compatible with the four extinguisher harness variations described on figure 2, and shall provide the signal assignments shown in table III (see 4.6.3).

3.3.5.3 Receptacle J3. Receptacle J3 shall communicate with the OFSA's. Receptacle J3 wiring shall be compatible with the four OFSA harness variations described on figure 3, and shall provide the signal assignments shown in table IV (see 4.6.3).

3.3.6 Electrical signals. The MSEC shall receive and transmit logic information and commands in the form of the four signals described in table I. The MSEC shall withstand signal short circuits of indefinite duration, and shall perform as specified within all indicated signal value ranges (see 4.6.3).

3.3.7 Extinguishing shots. The MSEC shall function as specified in either one or two shot systems without adjustment (see 4.6.3 and 6.4.4).

3.3.8 Component removal/replacement. Upon removal or replacement of any component, automatic protection shall be provided within the MSEC to preclude false activation of any of the extinguishers. Removal or replacement of any OFSA or extinguisher shall not render the remainder of the system inoperative (see 4.6.3).

3.3.9 Reliability. The mean time between failures shall be not less than 100,000 hours when calculated in accordance with MIL-HDBK-217. A failure shall be defined as any MSEC malfunction which prevents the system from responding as specified (excluding incidents caused by or exclusively to interconnecting electrical harnesses) (see 4.6.4).

## MIL-DTL-62545D

TABLE II. Test and alarm panel connection (J1). 1/

Pin	Function	In/Out	Signal (see table I)	Duration
A	<u>Power</u>	In	16 to 30 V dc in accordance with MIL-STD-1275 140 mA maximum quiescent	
N	<u>Return</u>	In	40 A maximum	
B	<u>Auxiliary power</u> : May be used as power source for test and alarm panel or auxiliary devices.	Out	16 to 30 V dc 2 A minimum	
M	<u>Return</u>	Out		
C	<u>Extinguisher number 1 status lamp signal</u>	Out	Signal D	Continuous when continuity is lost at Pins A or C, table III
D	<u>Extinguisher number 2 status lamp signal</u>	Out	Signal D	Continuous when continuity is lost at Pins F or H, table III
E	<u>Extinguisher number 3 status lamp signal</u>	Out	Signal D	Continuous when continuity is lost at Pins F or H, table III
F	<u>Extinguisher number 4 status lamp signal</u>	Out	Signal D	Continuous when continuity is lost at Pins S or U, table III
G	<u>Manual release signal</u> : Causes release of first shot. Second signal received after inhibit period of 4 to 6 s causes release of second shot (see 3.4.4).	In	10 to 30 V dc	
H	<u>BITE activation signal</u> : Initiates a test of sensing system in accordance with 3.4.6.	In	10 to 30 V dc	
J	<u>BITE "Pass" signal</u> : Produced after complete system test has been accomplished and system is completely functional (see 3.4.6).	Out	Signal D	4 to 6 s
K	<u>BITE "Fail" signal</u> : Produced if "BITE" finds a fault (see 3.4.6).	Out	Signal D	Until retest results in a pass indication
L	<u>Fire warning lamp signal</u> : Produced whenever an appropriate signal is received at any of the following pins in connector J3: D, M, W, or e (see 3.3.2.1).	Out	Signal D	As long as appropriate signal is received at Pin D, M, W, or e of connector J3.

See footnotes at end of table.

TABLE II. Test and alarm panel connection (J1) - Continued. <sup>1/</sup>

Pin	Function	In/Out	Signal (see table I)	Duration
T	<u>Ventilation fan activation signal:</u> Produced 8 to 10 s after extinguisher activation signal.	Out	16 to 30 V dc (suitable for operating a relay) source input impedance $\geq 20,000 \Omega$ (Signal D)	4 to 6 s
U	<u>Audible fire warning signal:</u> Produced whenever an appropriate signal is received at any of the following pins in connector J3: D, M, W, or e	Out	16 to 30 V dc (suitable for operating a relay) source input impedance $\geq 20,000 \Omega$ (Signal D)	Same as Pin L.
P	<u>OFSA 1 fault signal</u>	Out	Signal D	Same as Pin K
R	<u>OFSA 2 fault signal</u>	Out	Signal D	Same as Pin K
S	<u>Harness signal shield termination:</u> Connect to Pin N of connector J1 within MSEC.			
V	<u>OFSA 3 fault signal</u>	Out	Signal D	Same as Pin K
W	<u>OFSA 4 fault signal</u>	Out	Signal D	Same as Pin K
X	<u>MSEC fault signal</u>	Out	Signal D	Same as Pin K

<sup>1/</sup> MSEC connector J1 (to test and alarm panel), [see 3.3.5.](#)



TABLE III. Extinguisher connection (J2). <sup>1/</sup>

Pin	Function	In/Out	Signal (see table I)	Duration
A	<u>Extinguisher number 1 activation signal and continuous continuity monitor</u>	Out	Signal B and C	33 to 38 ms
B	<u>Extinguisher number 1 return</u>			
C	<u>Extinguisher number 1 pressure/flow monitor</u>	Out	High pressure and no flow-short to Pin B. Low pressure or flow-open circuit to Pin B.	
F	<u>Extinguisher number 2 activation signal and continuous continuity monitor</u>	Out	Signal B and C	33 to 38 ms
G	<u>Extinguisher number 2 return</u>			
H	<u>Extinguisher number 2 pressure/flow monitor</u>	Out	High pressure and no flow-short to Pin G. Low pressure or flow-open circuit to Pin G.	
L	<u>Extinguisher number 3 activation signal and continuous continuity monitor</u>	Out	Signal B and C	33 to 38 ms
M	<u>Extinguisher number 3 return</u>			
N	<u>Extinguisher number 3 pressure/flow monitor</u>	Out	High pressure and no flow-short to Pin M. Low pressure or flow-open circuit to Pin M.	
S	<u>Extinguisher number 4 activation signal and continuous continuity monitor</u>	Out	Signal B and C	33 to 38 ms
T	<u>Extinguisher number 4 return</u>			
U	<u>Extinguisher number 4 pressure/flow monitor</u>	Out	High pressure and no flow-short to Pin T. Low pressure or flow-open circuit to Pin T.	
D	<u>Harness signal shield termination</u> Connect to Pin N of connector J1 within MSEC			
E	<u>Unused</u>			

<sup>1/</sup> MSEC connector to J2 (to extinguishers), [see 3.3.5](#).

## MIL-DTL-62545D

TABLE IV. OFSA connections (J3). 1/

Pin	Function	In/Out	Signal (see table I)	Duration
A	<u>Power to OFSA number 1</u>	Out	15 to 30 V dc 150 mA minimum 15 mA minimum (quiescent)	
B	<u>Return from OFSA number 1</u>	Out		
C	<u>Large fire signal from OFSA number 1</u>	In	Signal A	1) As long as fire exceeds threshold, or 2) for not less than 5 ms and not more than 4.0 s following BITE signal.
D	<u>Small fire signal from OFSA number 1</u>	In	Signal A	Same as Pin C
E	<u>BITE signal to OFSA number 1</u>	Out	Signal A	5 ms to 4.0 s
J	<u>Power to OFSA number 2</u>	Out	15 to 30 V dc 150 mA minimum 15 mA minimum (quiescent)	
K	<u>Return from OFSA number 2</u>	Out		
L	<u>Large fire signal from OFSA number 2</u>	In	Signal A	Same as Pin C
M	<u>Small fire signal from OFSA number 2</u>	In	Signal A	Same as Pin C
N	<u>BITE signal to OFSA number 2</u>	Out	Signal A	5 ms to 4.0 s
T	<u>Power to OFSA number 3</u>	Out	15 to 30 V dc 150 mA minimum 15 mA minimum (quiescent)	
U	<u>Return from OFSA number 3</u>	Out		
V	<u>Large fire signal from OFSA number 3</u>	In	Signal A	Same as Pin C
W	<u>Small fire signal from OFSA number 3</u>	In	Signal A	Same as Pin C
X	<u>BITE signal to OFSA number 3</u>	Out	Signal A	5 ms to 4.0 s

See footnotes at end of table.

TABLE IV. OFSA connections (J3) - Continued. 1/

Pin	Function	In/Out	Signal (see table I)	Duration
b	<u>Power to OFSA number 4</u>	Out	15 to 30 V dc 150 mA minimum 15 mA minimum (quiescent)	
c	<u>Return from OFSA number 4</u>	Out		
d	<u>Large fire signal from OFSA number 4</u>	In	Signal A	Same as Pin C
e	<u>Small fire signal from OFSA number 4</u>	In	Signal A	Same as Pin C
f	<u>BITE signal to OFSA number 4</u>	Out	Signal A	5 ms to 4.0 s
F	<u>Harness signal shield termination.</u> Connect to Pin N of connector J1 within MSEC			
G	Unused			
H	Unused			
P	Unused			
R	Unused			
S	Unused			
Y	Unused			
Z	Unused			
a	Unused			
g	Unused			
h	Unused			
j	Unused			

1/ MSEC connector J3 (to OFSA's), [see 3.3.5](#).

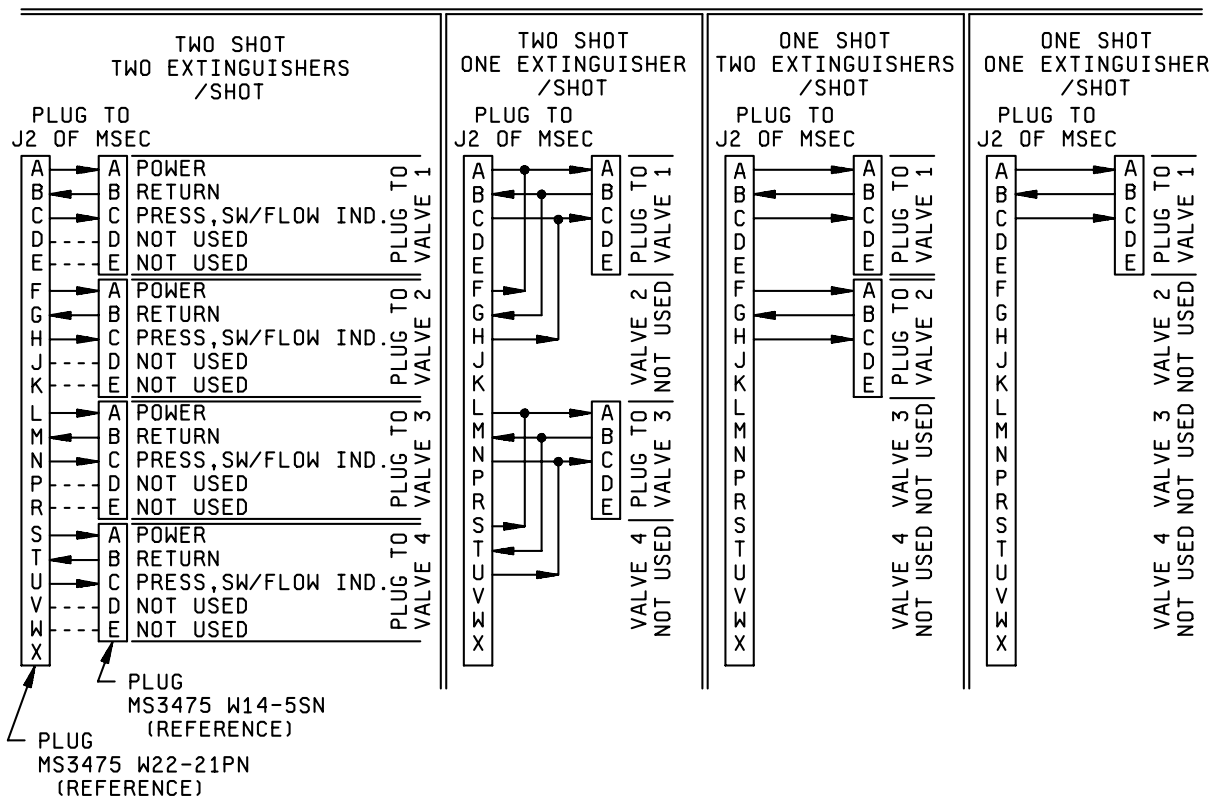
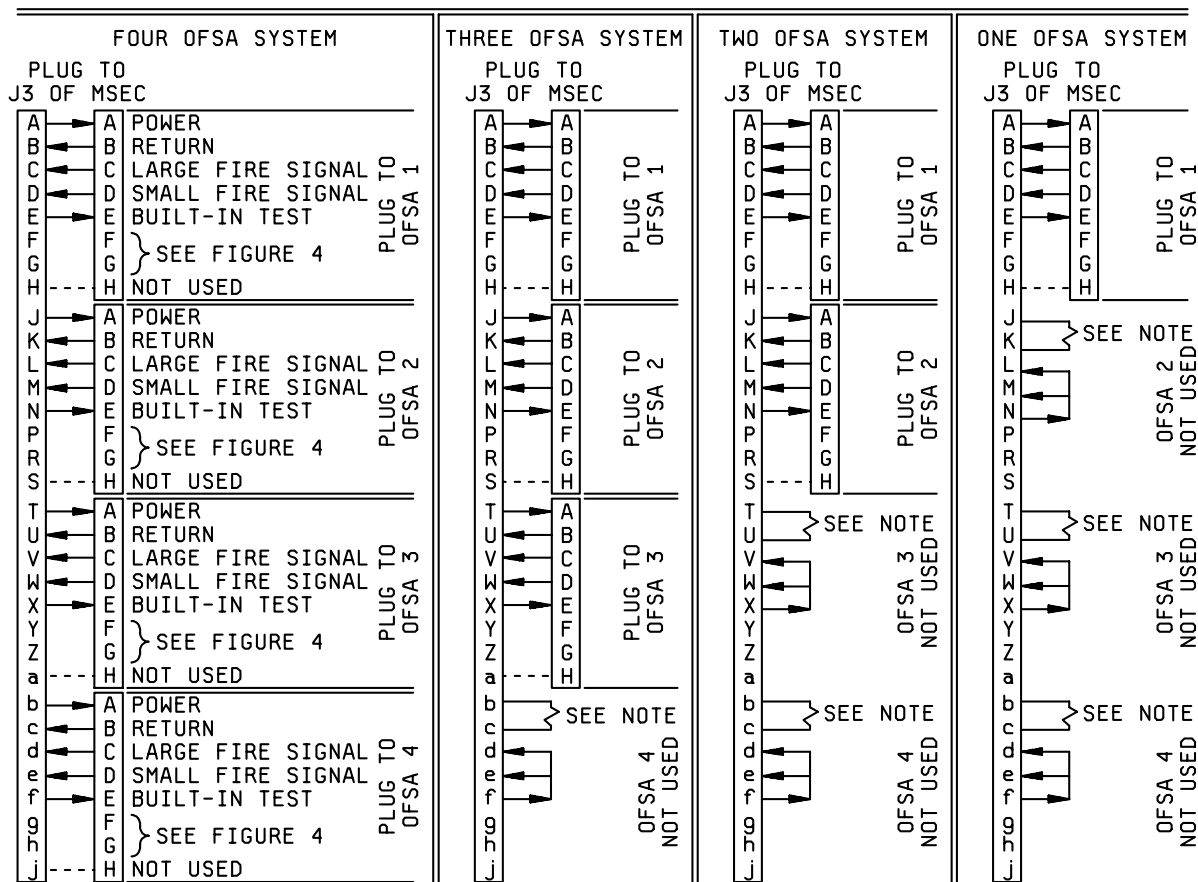

FIGURE 2. Harness variations for one to four extinguisher systems.



MS3475 W12-8SN (REFERENCE) ONLY  
 MS3475 W18-32PN (REFERENCE) ONLY

DOTTED LINES INDICATE WIRED BUT NOT USED

1/ 2 kΩ, 0.5 watt resistor.

FIGURE 3. Harness variations for one to four OFSA systems.

3.3.10 Voltage characteristics. The MSEC shall meet the requirements of MIL-STD-1275 without sustaining loss of effectiveness or causing damage or malfunction to any components which could result in loss of system effectiveness (see 4.6.5).

3.3.10.1 Input power. The MSEC shall be effective over an input voltage range of 16 to 30 V dc and shall not require more than 40 A when active or more than 140 mA during quiescent operation (see 4.6.5.1).

3.3.10.2 Start-up. The MSEC shall not false alarm (generate extinguisher drive signals, fire warning signals, or ventilation fan activation signals) upon the application of 16 to 30 V dc step inputs to pins A and N of connector J1 (initial power-on condition) (see 4.6.5.2).

3.3.10.3 Input voltage decay. The MSEC shall not false alarm when undergoing input voltage decays resulting from prolonged operation without recharging of the batteries (see 4.6.5.3).

3.3.10.4 Steady state voltage extremes. The MSEC shall sustain no damage from the application of any steady state voltage up to 40 V dc (see 4.6.5.4).

3.3.11 Polarity. The MSEC shall operate with a negatively grounded electrical circuit to the vehicle battery. The MSEC shall withstand a 28 V dc reverse polarity for a period of 30 minutes without false discharge or damage to any components (see 4.6.6).

#### 3.4 Performance.

3.4.1 Response time. At operating voltages between 16 and 30 V dc, and at temperatures of -17°C to 71°C (1°F to 160°F), the MSEC shall respond to an activation signal within 2 ms (see 4.6.7.1).

3.4.2 Small fire logic. When small fire signals (signal A of table I) are input to the appropriate sockets of connector J3 (see table IV), the output signals on the fire warning lamp and audible fire warning pins in connector J1 shall be energized as specified in table II (see 4.6.7.2).

3.4.3 Large fire logic. The MSEC shall produce extinguisher drive signals in accordance with figure 1 when a large fire signal is supplied for 1 to 2 s to appropriate sockets of connector J3 (see table II and table IV) (see 4.6.7.3).

3.4.4 Electrical-manual release. An electrical-manual release signal to the appropriate pin of connector J1 as specified in table II shall result in output signals on applicable extinguisher activation sockets of connector J2 (see table III) (see 4.6.7.4).

3.4.5 Extinguisher status. Loss of continuity on the activation circuit or on the pressure/flow circuit for a particular extinguisher shall result in output of signal D of table I on the respective extinguisher status lamp signal pin of connector J1 (see table II) (see 4.6.7.5).

3.4.6 BITE. When a BITE activation signal (signal A of table I) is provided at the appropriate pin of connector J1 (see table II), it shall produce BITE signals at the appropriate sockets of connector J3 (see table IV). Upon receipt of signals on all large and small fire signal input sockets (see table IV), and verification of proper MSEC operation, the MSEC shall produce a BITE "pass" signal at the appropriate pin of connector J1 (see table II). If the MSEC does not receive all fire signals within 5 s or the MSEC is not functioning properly, a BITE "fail" signal shall be produced on pin K, as well as "fail" signals for each defective component at the appropriate pin(s) of connector J1 (see table II). The pass or fail signals shall be as shown in table II (see 4.6.7.6).

3.4.7 Electromagnetic interference (EMI). The MSEC shall meet the following requirements of MIL-STD-461:

Conducted emission:	CE01, CE04
Conducted susceptibility:	CS01, CS02, CS06
Radiated emission:	RE02, RE02.1
Radiated susceptibility	RS02, RS03, RS03.1 non-sheltered.

In addition, the narrowband conducted emissions shall be in accordance with the limits of figure 4.

MIL-DTL-62545D

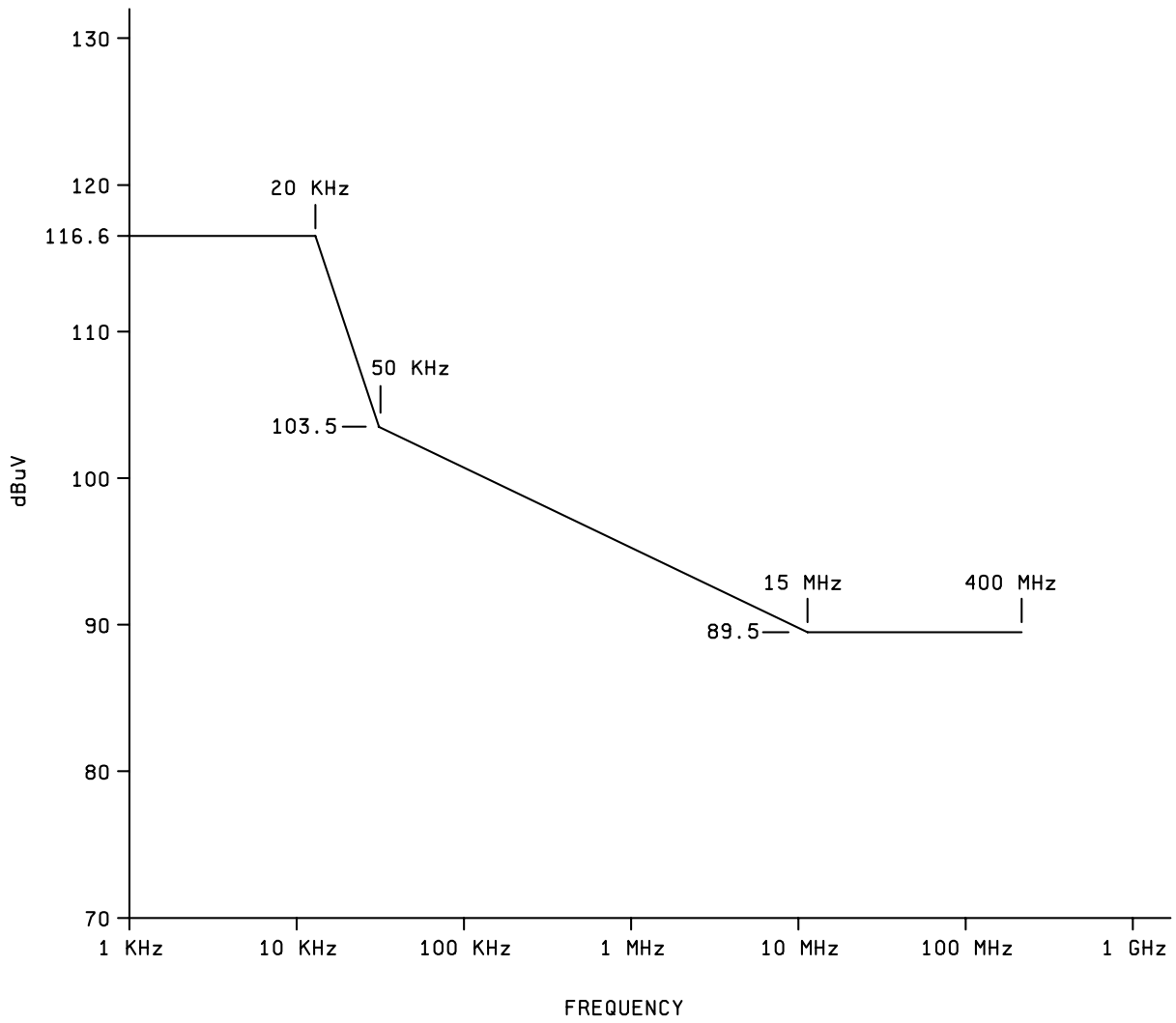

FIGURE 4. Narrowband conducted emission limit.

3.4.8 Nuclear hardening. Requirements for nuclear survivability shall be as specified in a separate classified (confidential) document entitled "Nuclear Survivability Criteria for the Automatic Fire Extinguishing Systems (AFES)" (U) (see 4.6.7.8 and 6.5).

3.4.9 Ventilation fan. The MSEC shall provide an activation signal to switch on the ventilation fan 8 to 10 s after activation of the fire extinguishers (see 4.6.3).

3.5 Environmental. The MSEC shall function satisfactorily, evidence no deterioration, and meet the requirements of 3.4.1 through 3.4.6 during or after, as specified, exposure to the following environments. The MSEC shall produce no false alarms during or after testing (see 4.6.8 and 6.4.5).

3.5.1 Temperature.

3.5.1.1 High temperature. The MSEC shall meet the requirements of 3.5 during extended exposure to a temperature of 71°C (160°F) (see 4.6.8.1.1).

3.5.1.2 Low temperature. The MSEC shall meet the requirements of 3.5 during extended exposure to a temperature of -51°C (-60°F) (see 4.6.8.1.2).

3.5.1.3 Temperature shock. The MSEC shall meet the requirements of 3.5 after rapid changes of temperature between -51°C and 71°C (-61°F and 160°F) (see 4.6.8.1.3).

3.5.2 Vibration. The MSEC shall meet the requirements of 3.5 during vibration at the amplitudes and frequencies shown on figure 5 in each of three mutually perpendicular axes (see 4.6.8.2).

3.5.3 Shock. The MSEC shall meet the requirements of 3.5 when subjected to sawtooth shock pulses of  $100 \pm 10$  g, with a duration of  $11 \pm 1.1$  ms. The pulses shall be applied in both directions of three mutually perpendicular axes (see 4.6.8.3 and figure 6).

3.5.4 Leakage.

3.5.4.1 Water immersion. The MSEC shall meet the requirements of 3.5 and shall not leak when immersed in water (see 4.6.8.4.1).

3.5.4.2 Diesel fuel immersion. The MSEC shall meet the requirements of 3.5 and shall not leak when immersed in diesel fuel conforming to DF-2 of A-A-52557 (see 4.6.8.4.2).

3.5.4.3 Water jet. The MSEC shall meet the requirements of 3.5 and shall not leak when exposed to water jet cleaning (see 4.6.8.4.3).

3.5.5 Salt fog. The MSEC shall meet the requirements of 3.5 and shall show no evidence of corrosion after prolonged exposure to a salt laden atmosphere (see 4.6.8.5).

3.5.6 Fungus. The MSEC shall meet the requirements of 3.5 and shall show no evidence of microbiological growth that could affect performance following prolonged exposure, in a non-operating mode, to an environment favorable to fungus growth (see 4.6.8.6).

3.5.7 Sand and dust. The MSEC shall meet the requirements of 3.5 after exposure to air driven sand and dust (see 4.6.8.7).

3.5.8 Humidity. The MSEC shall meet requirements of 3.5 during operation in a high humidity environment (see 4.6.8.8).



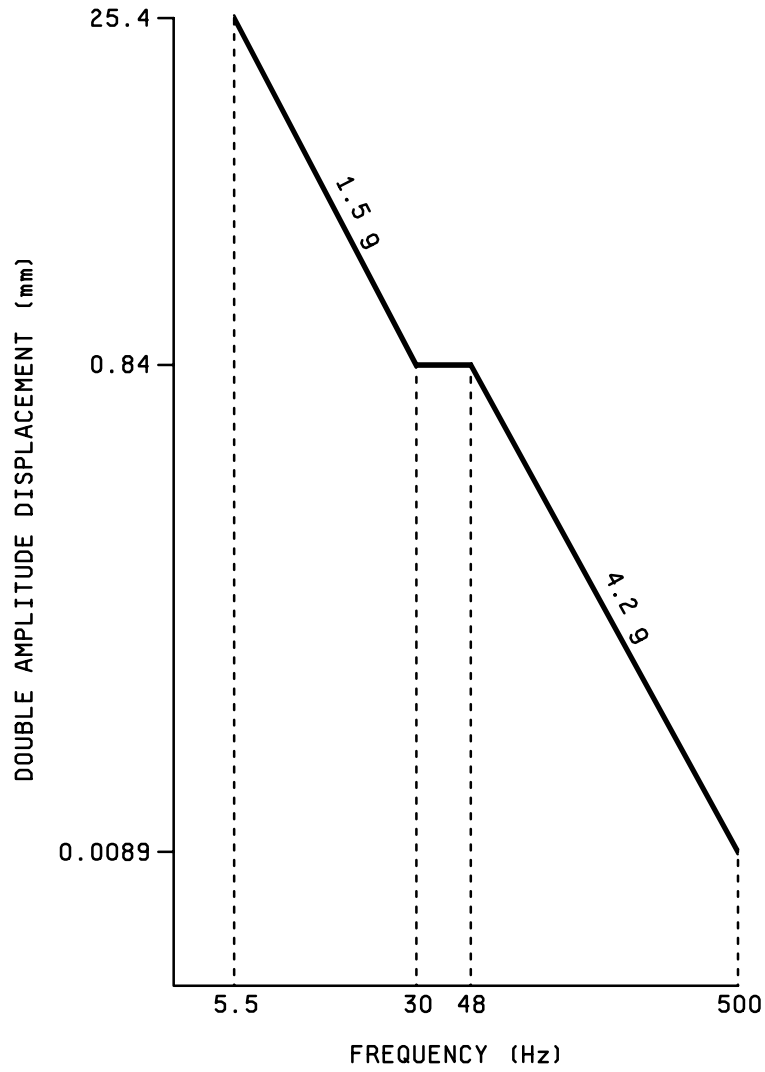

NOTES:

1. Hertz (Hz).
2. Gravity units (g).

FIGURE 5. Vibration test curve.

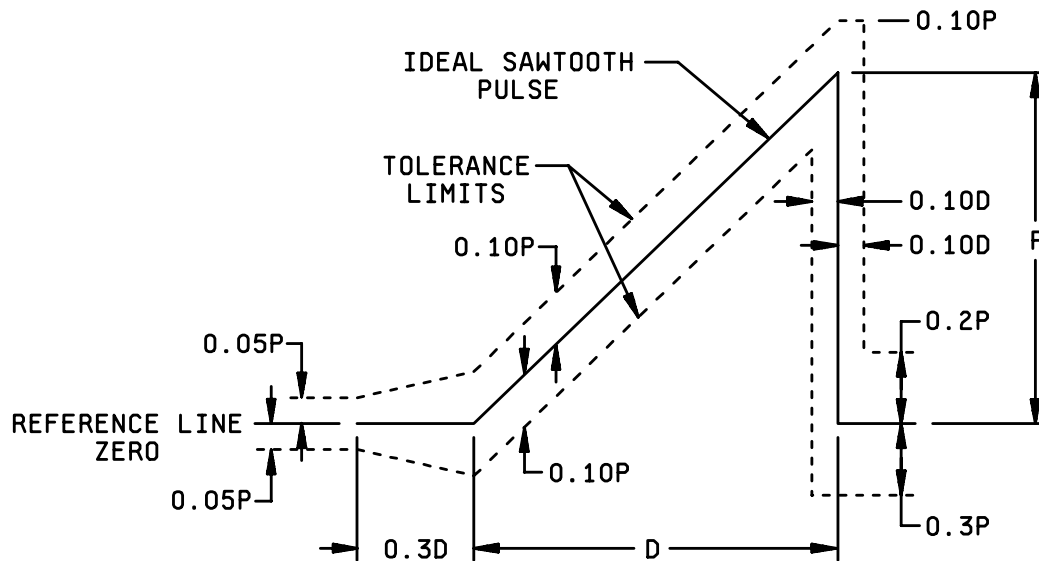

## NOTES:

1. The oscillogram shall include a time about  $3D$  long with a pulse located approximately in the center. The peak acceleration magnitude of the sawtooth pulse is  $P$  and its duration is  $D$ . The measured acceleration pulse shall be contained between the broken line boundaries and the measured velocity change (which may be obtained by integration of the acceleration pulse) shall be within the limits of  $V_i \pm 0.1 V_i$ , where  $V_i$  is the velocity-change associated with the ideal pulse which equals  $0.5 PD$ . The integration to determine velocity change shall extend from  $0.4D$  before the pulse to  $0.1D$  after the pulse.

FIGURE 6. Terminal-peak sawtooth shock pulse configuration and tolerance limits.

3.6 Finish. All component exterior surfaces of the MSEC, except mounting surfaces and electrical connectors, shall be painted in conformance with requirements of Drawing 12370459. The finish shall be uniform in coverage and free from runs or sags (see 4.6.2).

3.7 Identification nameplate and markings.

3.7.1 Nameplate. The MSEC shall have a nameplate attached in a conspicuous location. The nameplate shall have the following minimum information (see 4.6.2):

- a. Component name.
- b. National Stock Number (NSN).
- c. Serial number.
- d. Manufacturer's Name or Identification Code.

3.7.2 Marking. The MSEC shall be marked in accordance with Drawing 12370459 and MIL-STD-130 (see 4.6.2).

3.8 Workmanship. Workmanship shall assure a product free of burrs, scratches, sharp edges, chips, corrosion, scale, and dirt; (refer to guideline 9 of MIL-HDBK-454 for guidance) (see 4.6.2).

4. VERIFICATION

4.1 Classification of inspection:

- a. First article inspection (see 4.3).
- b. Conformance inspection (see 4.4).
- c. Control tests (see 4.5).

4.2 Inspection conditions. Unless otherwise specified (see 6.2), all inspections shall be conducted under the following conditions:

- a. Air temperature:  $23^{\circ}\text{C} \pm 10^{\circ}\text{C}$  ( $73^{\circ}\text{F} \pm 18^{\circ}\text{F}$ ).
- b. Barometric pressure: 725 +50, -75 millimeters of mercury (mm Hg) (28.5 +2, -3 inches of mercury (in Hg)).
- c. Relative humidity:  $50 \pm 30$  percent.

4.2.1 Voltage setting. For all tests, input voltage to the MSEC shall be supplied by batteries (16 to 30 V dc) or a variable power supply capable of 40 A current draw, as specified herein or as appropriate.

4.2.2 Test temperature stabilization. Tests shall be conducted after the test sample has been allowed sufficient time for temperature stabilization. Test temperature stabilization is the point at which the test sample will not vary in temperature more than  $2^{\circ}\text{C}$  ( $3.6^{\circ}\text{F}$ ) per hour.

4.3 First article inspection. First article inspection shall consist of all the examinations and tests of this specification, as specified in table V.

4.3.1 First article samples. Unless otherwise specified, first article samples shall consist of four MSEC's. The first article samples, produced with equipment and procedures used in production, shall be forwarded to a test facility set forth in the letter of authorization to submit samples. The samples shall be plainly identified by securely attached durable tags marked with the following information:

Sample submitted by (name) (date) for first article inspection in accordance with the requirements of MIL-DTL-62545 and number under authorization (reference authorizing letter and number).

TABLE V. Classification of inspections.

Title	Requirement	Inspection	First article samples				Conformance		Control
			1	2	3	4	Examination	Tests	
Materials and construction	3.2 through 3.2.2, 3.3, 3.3.4, 3.3.5	4.6.1	X						
Defects (see table VI)	3.3.4, 3.3.5, 3.6 through 3.8	4.6.2	X	X	X	X	X		
Features	3.3.1 through 3.3.3, 3.3.5 through 3.3.8, and 3.4.9	4.6.3	X	X					
Reliability	3.3.9	4.6.4	X	X	X	X			
Voltage characteristics	3.3.10	4.6.5	X	X					X
Polarity	3.3.11	4.6.6			X	X			
Reverse polarity	3.3.11	4.6.6			X	X			
Performance	3.4	4.6.7							
Response time	3.4.1	4.6.7.1	X	X	X	X			X
Small fire logic	3.4.2	4.6.7.2	X	X	X	X		X	
Large fire logic	3.4.3	4.6.7.3	X	X	X	X		X	
Electrical-manual release	3.4.4	4.6.7.4	X	X	X	X		X	
Extinguisher status	3.4.5	4.6.7.5	X	X	X	X		X	
BITE	3.4.6	4.6.7.6	X	X	X	X		X	
EMI	3.4.7	4.6.7.7	X	X					
Nuclear hardening	3.4.8	4.6.7.8	X	X					X

TABLE V. Classification of inspections- Continued.

Title	Requirement	Inspection	First article samples				Conformance		Control
			1	2	3	4	Examination	Tests	
Environmental	3.5	4.6.8							
Temperature	3.5.1	4.6.8.1							
High temperature	3.5.1.1	4.6.8.1.1	X	X	X	X			X
Low temperature	3.5.1.2	4.6.8.1.2	X	X	X	X			X
Temperature shock	3.5.1.3	4.6.8.1.3	X	X	X	X			X
Vibration	3.5.2	4.6.8.2			X	X			X
Shock	3.5.3	4.6.8.3			X	X			X
Leakage	3.5.4	4.6.8.4							
Water immersion	3.5.4.1	4.6.8.4.1	X	X	X	X		X	
Diesel fuel immersion	3.5.4.2	4.6.8.4.2			X	X			
Water jet	3.5.4.3	4.6.8.4.3			X	X			
Salt fog	3.5.5	4.6.8.5			X	X			
Fungus	3.5.6	4.6.8.6	X	X					
Sand and dust	3.5.7	4.6.8.7			X	X			
Humidity	3.5.8	4.6.8.8			X	X			

4.4 Conformance inspection. Conformance inspection shall include the examination of 4.4.1 and tests of 4.4.2 (see 6.2). Non-conformance with any of the specified requirements in section 3 shall be cause for rejection.

4.4.1 Examination. The MSEC shall be examined for the defects specified in table VI.

4.4.2 Tests. Each MSEC shall be subjected to the conformance tests specified in table V.

4.5 Control tests. MSEC selected for control tests shall be new and subjected to the control tests specified in table V (see 6.2).

TABLE VI. Classification of defect examinations.

Defect Category	Defect Examination	Method of inspection
Critical	None	
<u>Major</u>		
101	Incorrect dimensions affecting interchangeability (see 3.3.4).	SIE <u>1/</u>
102	Damaged connectors (see 3.3.5)	Visual
103	Improper nameplate (see 3.7.1)	Visual
104	Improper identification markings (see 3.7.2)	Visual
<u>Minor</u>		
201	Incorrect dimensions not affecting interchangeability (see 3.3.4)	SIE <u>1/</u>
202	Improper finish (see 3.6)	Visual
203	Faulty workmanship (see 3.8)	Visual

1/ SIE = Standard Inspection Equipment.

#### 4.6 Methods of inspection.

4.6.1 Materials and construction. Conformance to 3.2 through 3.2.2, 3.3, 3.3.4, and 3.3.5 shall be determined by inspection of contractor records providing proof or certification that design, construction, processing, and materials conform to requirements. Applicable records shall include drawings, specifications, design data, receiving inspection records, processing and quality control standards, vendor catalogs and certifications, industry standards, test reports, and rating data.

4.6.2 Defects. Conformance to 3.3.4, 3.3.5, and 3.6 through 3.8 shall be determined by examination for the defects listed in table VI. Examination shall be visual or by measurement with SIE.

4.6.3 Features. Conformance to 3.3.1 through 3.3.3, 3.3.5 through 3.3.8, and 3.4.9 shall be determined by exercising the MSEC, and by qualitative observation sufficient to demonstrate that specified characteristics and features are present and functional.

4.6.4 Reliability. To determine conformance to 3.3.9, a reliability prediction analysis shall be conducted (using MIL-HDBK-217 for guidance) for the MSEC electronic design. A report containing detailed parts lists and reliability calculations for the MSEC shall be available for review by the Government.

4.6.5 Voltage characteristics. To determine conformance to 3.3.10, the MSEC shall be subjected to the electrical power characteristics in MIL-STD-1275, and shall not false alarm. The MSEC shall meet the applicable requirements of table I before, during, and after testing.

4.6.5.1 Input power. To determine conformance to 3.3.10.1, the MSEC shall be connected to a variable power supply set at 24 V dc with appropriate loads connected. Current and voltage readings shall be taken both during quiescent operation and while large fire signals are input to the appropriate pins of connector J3. The test shall be repeated at 16, 28, and 30 V dc.

4.6.5.2 Start-up. To determine conformance to 3.3.10.2, the MSEC shall stand in an inactive mode. 16 V dc shall then be applied across pins A and N of connector J1 according to table II. There shall be no output signals at pins L, T, and V of connector J1 and pins A, F, L, and S of connector J2. The test shall be repeated at 24, 28, and 30 V dc.

4.6.5.3 Input voltage decay. To determine conformance to 3.3.10.3, the MSEC shall be connected to a variable power supply capable of 40 A current draw. Set the power supply at 30 V dc, with the MSEC in the quiescent mode. Gradually decrease the voltage to zero over 5 to 10 minutes. There shall be no output signals at pins L, T, and V of connector J1 and pins A, F, L, and S of connector J2. The test shall be repeated three times.

4.6.5.4 Steady state voltage extremes. To determine conformance to 3.3.10.4, the MSEC shall be connected to a variable power supply. The voltage shall be set at 5 V dc for 3 minutes of quiescent operation. Voltage shall then be increased in 5 V dc increments for 3-minute intervals until reaching 40 V dc. The MSEC shall subsequently pass the tests specified in 4.6.7.1 through 4.6.7.6.

4.6.6 Polarity. To determine conformance to 3.3.11, the MSEC shall be connected for 28 V dc battery operation with negative ground. The connections on the battery then shall be reversed to create the reverse polarity condition and remain in this state for 30 minutes. The MSEC shall then be rewired properly and shall evidence no damage or performance degradation.

#### 4.6.7 Performance.

4.6.7.1 Response time. To determine conformance to 3.4.1, the MSEC's response time shall be measured at supply voltages of 16, 24, and 30 V dc. The response time shall be not more than 2 ms. This test shall be conducted at -17°C to +71°C (+1°F to +160°F).

4.6.7.2 Small fire logic. To determine conformance to 3.4.2, small fire signals corresponding to signal A of table I shall be sequentially applied to each of the four small fire signal pins within connector J3 (see table IV). The output signals on the fire warning lamp and audible fire warning pins in connector J1 shall be as specified in table II.

4.6.7.3 Large fire logic. To determine conformance to 3.4.3, the MSEC shall be wired to short circuit appropriate pins in connector J2 (see table III) to simulate the availability of four extinguishers. A large fire signal and a small fire signal shall be supplied simultaneously for 1 to 2 s at one of the OFSA inputs (see table IV). Response to this signal shall be extinguisher drive signals as indicated in table III. The signals shall be produced at the proper time and in the sequence indicated in figure 1. The test shall be repeated three times (one for each remaining large fire input).

4.6.7.4 Electrical-manual release. To determine conformance to 3.4.4, the electrical-manual release signal specified in table II shall be supplied to pin G of connector J1, and shall result in output signals on the appropriate extinguisher activation sockets of connector J2 (see table III).

4.6.7.5 Extinguisher status. To determine conformance to 3.4.5, continuity shall be established on appropriate sockets of connector J2 with the necessary signals to simulate extinguishers in the circuit. Continuity shall be interrupted and then restored for the extinguisher activation circuit and then the pressure/flow circuit. The extinguisher status lamp pins of connector J1 (see table II) shall be monitored for the appropriate outputs. This shall be repeated for each of the four simulated extinguishers.

4.6.7.6 BITE. To determine conformance to 3.4.6, the MSEC shall be wired such that BITE signals produced at appropriate sockets (one for each OFSA) of connector J3 (see table IV and figure 3) are returned to both associated fire signal pins. Upon receipt of a BITE activation signal at the appropriate pin of connector J1 (see table II), a BITE "pass" signal shall be produced at pin J of connector J1 (see table II). The wiring shall be changed so that one or more of the BITE signals are not returned to the MSEC. Upon receipt of a BITE activation signal, BITE "fail" signals shall be generated at the appropriate pins of connector J1 (see table II).

4.6.7.7 EMI. To determine conformance to 3.4.7, the MSEC shall be subjected to the tests of MIL-STD-461 and figure 4. Narrowband conducted emissions of figure 4 shall be verified in accordance with the basic methodology of MIL-STD-461. The MSEC shall not false alarm or cause any EMI problems for other vehicle components.

#### 4.6.7.8 Nuclear hardening (see 6.6).

4.6.7.8.1 Qualification. Conformance to 3.4.8 shall be determined on the basis of circuit analysis or component testing.

4.6.7.8.2 Control. Conformance to 3.4.8 shall be determined by inspection of contractor records providing certification that the MSEC's have been fabricated in accordance with the design verified and approved during qualification.

4.6.8 Environmental. The MSEC shall be operated in the extinguisher monitoring mode except as otherwise specified herein. The MSEC shall pass the tests specified in 4.6.7.1 through 4.6.7.6 during or after environmental tests as specified. There shall be no false alarms.

4.6.8.1 Temperature. To determine conformance to 3.5.1, the MSEC shall be tested as specified in 4.6.8 during exposure to the environments specified in 4.6.8.1.1 and 4.6.8.1.2.

4.6.8.1.1 High temperature. To determine conformance to 3.5.1.1, the MSEC shall be placed in an oven and the temperature maintained at 71°C (160°F). A 22 to 28 V dc battery, external to the oven, shall be connected to the MSEC and be capable of producing (through the MSEC) two extinguisher drive signals simultaneously at no less than 20 A total. The MSEC shall be allowed to thermally stabilize for 24 hours and then maintained at high temperature for a period of 200 ± 24 hours. There shall be no false alarms. A recorder, with at least four channels, shall measure and record voltage across each extinguisher activation pin continuously during the test for indications of any false alarms. The samples shall be inspected at least two times per day, a minimum of 4 hours apart, and the inspection shall be noted on the recorder's trace. During these inspections, the MSEC shall be checked by energizing appropriate connector points to activate the extinguisher drive circuitry and BITE, and these operations noted on the trace.

4.6.8.1.2 Low temperature. To determine conformance to 3.5.1.2, the MSEC shall be placed in a low temperature test chamber. The instrumentation requirements shall be as specified in 4.6.8.1.1. The test conditions of 4.6.8.1.1 shall apply, except the chamber temperature shall be maintained at -51°C (-60°F).

4.6.8.1.3 Temperature shock. To determine conformance to 3.5.1.3, the MSEC shall be put through three high temperature to low temperature cycles as described below. The instrumentation requirements shall be as in 4.6.8.1.1 and 4.6.8.1.2 as to type(s) and location(s). The MSEC shall be set up and checked by energizing appropriate connector points to activate the extinguisher drive circuitry and BITE. The MSEC shall be exposed to ambient temperature for no more than 5 minutes during transfer. The procedures of 4.6.8.1.1 and 4.6.8.1.2 apply except:

- Step 1. The MSEC shall be placed in an oven preheated to +71°C (+160°F) and maintained for 24 ± 2 hours. While at this high temperature, the MSEC shall be checked as described in 4.6.8.1.1.
- Step 2. Immediately following step 1, the MSEC shall be transferred to a precooled low temperature chamber and maintained at -51°C (-60°F) for a period of 24 ± 2 hours. While at this low temperature, the MSEC shall be checked as described in 4.6.8.1.1.
- Step 3. Repeat step 1.
- Step 4. Repeat step 2.
- Step 5. Repeat step 1.
- Step 6. Repeat step 2. Twenty minutes after transfer, the tests of 4.6.7.3 and 4.6.7.6 shall be performed. The MSEC shall be returned to ambient temperature and shall pass the tests specified in 4.6.8.

4.6.8.2 Vibration. To determine conformance to 3.5.2, the MSEC shall be mounted in its production installation configuration or equivalent. The vibration level shall be in accordance with figure 5, applied in 15 minute sweep times in accordance with figure 7. Resonant search and dwell of 30 minutes at each of the four most severe resonant frequencies shall be part of the total cycle time of 3 hours. The MSEC shall pass the tests specified in 4.6.8 during exposure.

4.6.8.3 Shock. To determine conformance to 3.5.3, the MSEC shall be mounted in its production installation configuration or equivalent and exposed to the shock pulses defined in 3.5.3 three times in each of three mutually perpendicular axes. The MSEC shall be monitored for false discharges during the test. The MSEC shall pass the tests specified in 4.6.8 after exposure.



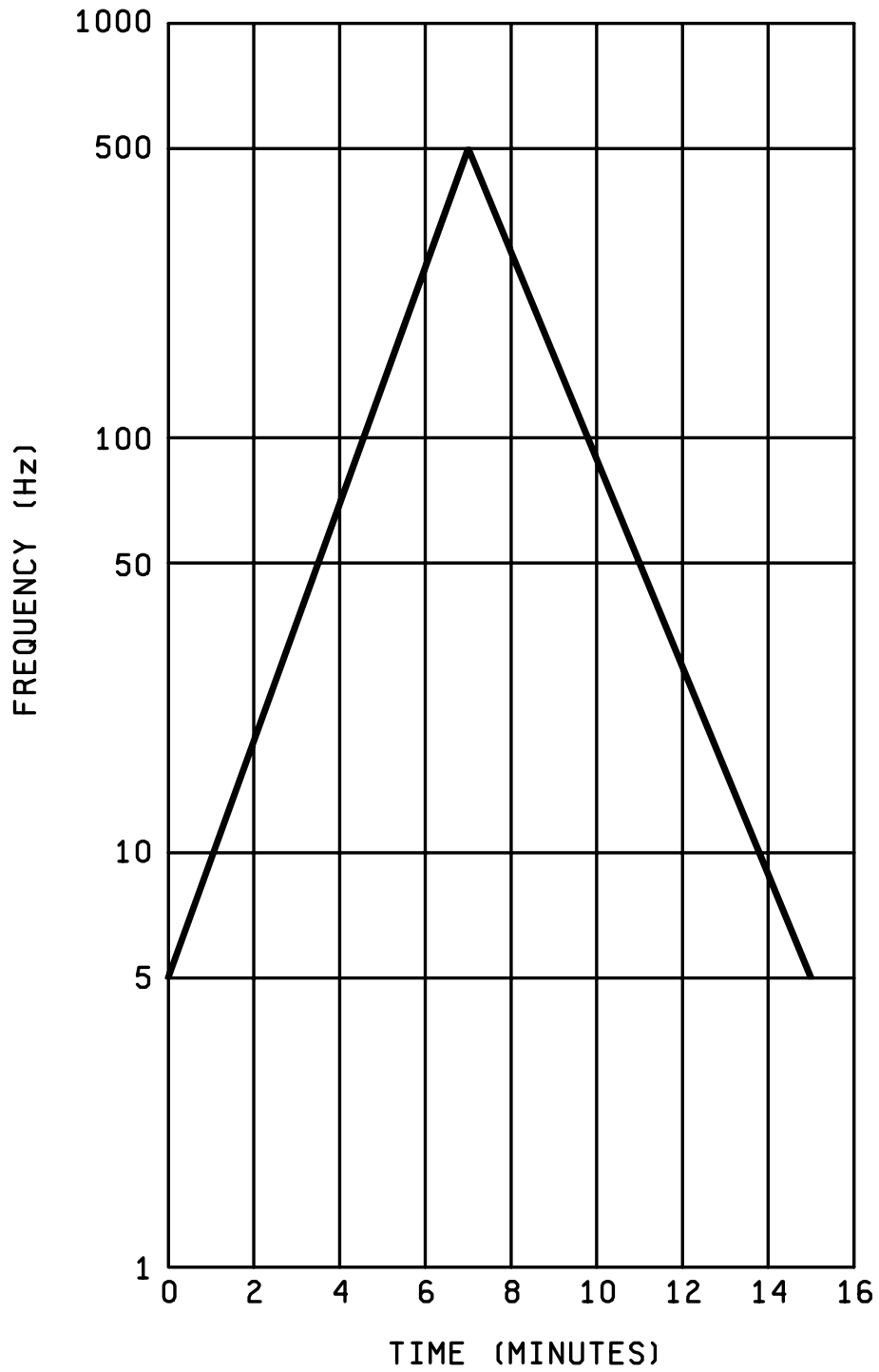

FIGURE 7. Logarithmic sweep.

4.6.8.4 Leakage. The MSEC shall not be operated during the following tests. The MSEC shall not evidence any leakage. Subsequent to these tests the MSEC shall pass the tests specified in 4.6.8.

4.6.8.4.1 Water immersion. To determine conformance to 3.5.4.1, a non-operating MSEC shall be submerged in water by one of the two methods below. Bubbles coming from within the MSEC shall be considered leakage. However, bubbles which result from trapped air on external surfaces of the MSEC shall not be considered leakage. The MSEC shall subsequently pass the tests specified in 4.6.8.

- a. The temperature of the water and the MSEC shall be  $23^{\circ}\text{C} \pm 10^{\circ}\text{C}$  ( $73^{\circ}\text{F} \pm 18^{\circ}\text{F}$ ). The MSEC shall be immersed in water so that the uppermost part of the MSEC is  $50 \text{ mm} \pm 25 \text{ mm}$  (2 inch  $\pm$  1 inch) below the surface of the water. The initial air pressure above the water shall be reduced to 480 mm Hg (19.0 inch Hg) absolute and maintained for 1 minute or until air bubbles substantially cease to be given off by the water, whichever is longer. The air pressure above the water shall then be increased to 510 mm Hg (20 inch Hg) absolute and maintained for 60 minutes.
- b. The MSEC shall be tested in accordance with MIL-STD-810, method 512.2, procedure I. The MSEC shall be heated  $27^{\circ}\text{C}$  ( $49^{\circ}\text{F}$ ) above the water temperature of  $23^{\circ}\text{C} \pm 10^{\circ}\text{C}$  ( $73^{\circ}\text{F} \pm 18^{\circ}\text{F}$ ) and submerged to a depth of 1 meter (39.4 inches).

4.6.8.4.2 Diesel fuel immersion. Prior to immersion in diesel fuel conforming to grade No. 2-D of A-A-52557, the temperature of the MSEC shall be  $45^{\circ}\text{C} \pm 3^{\circ}\text{C}$  ( $113^{\circ}\text{F} \pm 5^{\circ}\text{F}$ ); the temperature of the diesel fuel shall be  $18^{\circ}\text{C} \pm 5^{\circ}\text{C}$  ( $64^{\circ}\text{F} \pm 9^{\circ}\text{F}$ ). The container shall be of sufficient capacity so that immersion of the MSEC shall not raise the temperature of the fuel more than  $3^{\circ}\text{C}$  ( $5^{\circ}\text{F}$ ). The MSEC shall remain immersed for  $120 \pm 5$  minutes. The uppermost point of the MSEC shall be at least 50 mm (2 inches) below the surface. Upon completion of the test period, remove the MSEC from the diesel fuel and wipe the exterior surfaces only. The MSEC shall be weighed before and after this test. The weights shall not vary more than 0.5 gram (0.02 ounce).

4.6.8.4.3 Water jet. To determine conformance to 3.5.4.1, a water jet spray shall be applied at right angles to surfaces of a non-operating MSEC at a distance of 300 mm (12 inches) from the surface to the jet. The surface shall be cleaned at not less than 0.02 square meter per minute (0.2 square feet per minute). The water jet shall be derived from a nozzle having an orifice diameter of not more than 6 mm (.25 inch) and a nozzle pressure of  $345 \pm 105 \text{ kPa}$  ( $50 \pm 15 \text{ psi}$ ).

4.6.8.5 Salt fog. To determine conformance to 3.5.5, a non-operating MSEC shall be subjected to the tests of MIL-STD-810, method 509.2, except the test shall last 200 hours. The MSEC shall subsequently pass the tests specified in 4.6.8.

4.6.8.6 Fungus. To determine conformance to 3.5.6, a non-operating MSEC shall be subjected to the fungal incubation as specified in ASTM-G21, for a period of 90 days. The MSEC shall not demonstrate a susceptibility to fungal growth that could cause its performance to fall outside the limits specified herein. The MSEC shall subsequently pass the tests specified in 4.6.8 without cleaning.

4.6.8.7 Sand and dust. To determine conformance to 3.5.7, a non-operating MSEC with connectors attached shall be tested in accordance with MIL-STD-810, method 510.2, procedure I. The high temperature portion of testing shall be conducted at  $71^{\circ}\text{C}$  ( $160^{\circ}\text{F}$ ). The MSEC shall subsequently pass the tests specified in 4.6.8.

4.6.8.8 Humidity. To determine conformance to 3.5.8, the MSEC shall pass the tests specified in 4.6.8 during and after exposure to warm, high relative humidity in accordance with the applicable conditioning procedure for ground electronic equipment of MIL-STD-810, method 507.2. After conditioning, the MSEC shall be exposed to five continuous 48 hour cycles in accordance with figure 8. Prior to post exposure operation, the MSEC shall be conditioned for 24 hours at  $23^{\circ}\text{C} \pm 3^{\circ}\text{C}$  ( $73^{\circ}\text{F} \pm 5^{\circ}\text{F}$ ) and 50 percent  $\pm$  10 percent relative humidity.

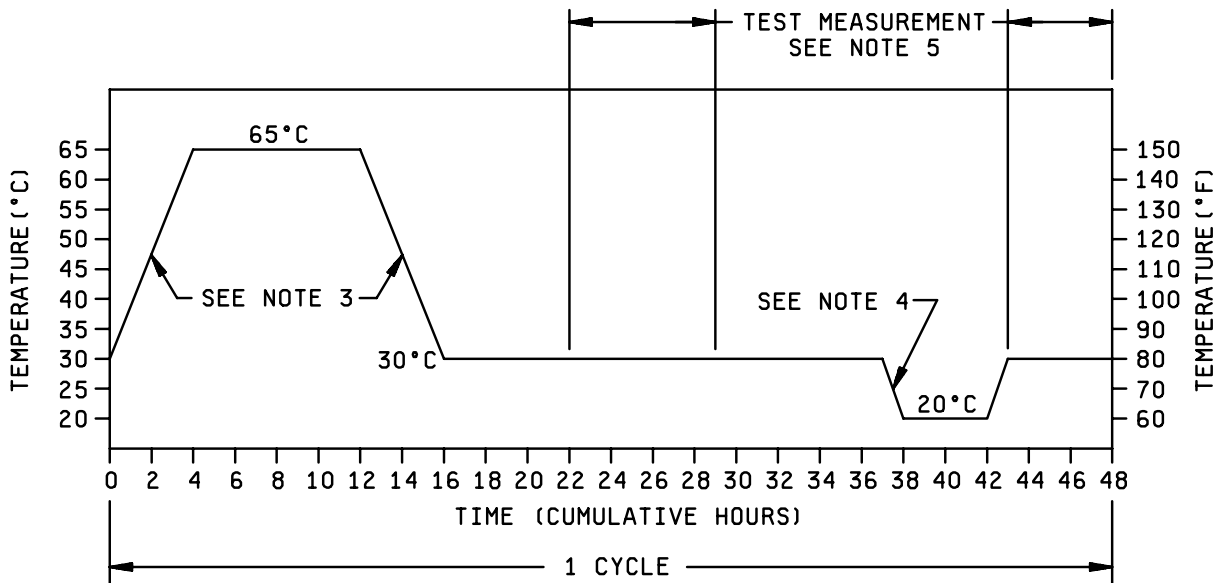

## NOTES:

1. Tolerance during temperature change shall be not greater than 3°C (5°F).
2. Relative humidity shall be maintained at  $94 \pm 4$  percent at all times, except that during the descending temperature period, the relative humidity may be permitted to drop as low as 85 percent.
3. Rate of temperature change between 30°C and 65°C (86°F and 149°F) shall be not less than 8°C (14.4°F) per hour.
4. The temperature increase in this portion of the curve shall be not less than 10°C (18°F).
5. Test measurements shall be taken only at the period specified in the applicable equipment or system specification.

FIGURE 8. Humidity cycle.

## 5. PACKAGING

5.1 Packaging. For acquisition purposes, the packaging requirements shall be as specified in the contract or order ([see 6.2](#)). When packaging of materiel is to be performed by DoD or in-house contractor personnel, these personnel need to contact the responsible packaging activity to ascertain packaging requirements. Packaging requirements are maintained by the Inventory Control Point's packaging activities within the Military Service or Defense Agency, or within the military service's system commands. Packaging data retrieval is available from the managing Military Department's or Defense Agency's automated packaging files, CD-ROM products, or by contacting the responsible packaging activity.

## 6. NOTES

(This section contains information of a general or explanatory nature that may be helpful, but is not mandatory.)

6.1 Intended use. The MSEC is a basic component of an optical fire sensing system designed to quickly detect and extinguish hydrocarbon fires in military ground combat and tactical vehicles (such as the M992 Field Artillery Ammunition Support Vehicle (FAASV)). The MSEC continuously monitors the system, and upon receipt of a fire signal from the optical fire sensor it issues crew warnings by energizing fire warning lamps and an audible fire warning signal and by issuing extinguisher discharge commands.

6.2 Acquisition requirements. Acquisition documents must specify the following:

- a. Title, number, and date of this specification.
- b. Packaging requirements ([see 5.1](#)).
- c. Responsibility for inspection, and place of inspection.
- d. First article inspection, if other than as specified ([see 4.3](#)).
- e. Sample size for conformance inspection and conformance inspection acceptance criteria ([see 4.4](#) and [6.6.1](#)).
- f. Control test sample size, frequency of tests, and disposition of lots and defective items ([see 4.5](#) and [6.6.2](#)).
- g. Inspection of packaging, sample size for each category, approval of test results, and disposition of defective items ([see 4.6](#)).
- h. Selection of applicable level and applicable packaging requirements ([see 5.1](#)).

6.3 Supersession data. This document supersedes all previous revisions of MIL-M-62545, and that portion of TACOM purchase description ATPD 2070, Edition 6, revision A, 29 February 1984; Sensor, Fire, Optical: System with Amplifier, Standard Control, Electronic, which pertains to the MSEC.

6.4 Definitions.

6.4.1 Recovered materials. "Recovered materials" means materials that have been collected or recovered from solid waste ([see 6.4.2](#)).

6.4.2 Solid waste. "Solid waste" means (a) any garbage, refuse, or sludge from a waste treatment plant, water supply treatment plant, or air pollution control facility; and (b) other discarded material, including solid, liquid, semisolid, or contained gaseous material resulting from industrial, commercial, mining, and agricultural operations, and from community activities. It does not include solid or dissolved materials in domestic sewage, or solid or dissolved material in irrigation return flows or industrial discharges which are point sources subject to permits under section 402 of the Clean Water Act. (33 U.S.C. 1342 et seq.), or source, special nuclear, or byproduct material as defined by the Atomic Energy Act of 1954 (42 U.S.C. 2011 et. seq.) (Source: Federal Acquisition Regulations, section 23.402).

6.4.3 Automatic back-up. This is the capability of the MSEC to activate an alternate extinguisher(s) when the MSEC determines that flow did not occur from the originally selected extinguisher(s).

6.4.4 One/two shot system. Indicates the number of separate extinguishing actions (discharging or extinguishant) of which a particular fire extinguishing system is capable. An extinguishing action consists of activating either one or two extinguishers.

6.4.5 False alarm. A false alarm exists when any MSEC output signal is produced without proper input stimuli.

6.4.6 Pressure. Unless otherwise specified, all pressures specified in this document are gauge.

6.5 Nuclear survivability criteria. Vendors requesting the nuclear survivability criteria, which is classified confidential, must possess the proper security clearance and a demonstrated need to know (see 2.2.2 and 3.4.8).

6.6 Inspection. The following information is presented as guidance for the contracting officer in specifying sampling and acceptance procedures for conformance inspection and control testing in acquisition documents.

6.6.1 Conformance inspection.

6.6.1.1 Sampling.

6.6.1.1.1 Lot formation. A lot should consist of all the MSEC's of one type and Part or Identifying Number (PIN), from an identifiable production period, from one manufacturer, submitted at one time for acceptance.

6.6.1.1.2 Sampling plan. Statistical sampling and inspection is performed on an inspection lot basis with a random sample of MSEC's selected in accordance with table VII. Acceptance is based upon the zero defective sampling plan. No failures are permitted.

TABLE VII. Conformance inspection sampling plan.

Lot size	Sample size
1 - 13	100 percent
14 - 150	13
151 - 280	20
281 - 500	29
501 - 1,200	34
1,201 - 3,200	42
3,201 - 10,000	50
10,001 - 35,000	60
35,001 - 150,000	74
150,001 - 500,000	90
500,001 and over	102

6.6.1.2 Acceptance. Samples selected in accordance with 6.6.1.1.2 should be examined for the defects listed in table VI. Acceptance is based upon the zero defective sampling plan. No failures are permitted.

6.6.2 Control tests. For control test purposes, consideration should be given to randomly select one MSEC from each lot of 250 units consecutively produced, except that not more than one MSEC should be tested in a 30-day period, nor less than one MSEC tested in a 6 month period.

6.7 Subject term (key word) listing.

- Activation sequence
- Amplifier, fire extinguishing system
- Automatic back-up
- Control module (amplifier) for fire extinguishing system
- Diesel fuel immersion
- Electronic control for fire extinguishing system
- Fire signals
- Nuclear survivability
- Response time
- Ventilation fan
- Warning signals

6.8 Tin whisker growth. The use of alloys with tin content greater than 97 percent, by mass, may exhibit tin whisker growth problems after manufacture. Tin whiskers may occur anytime from a day to years after manufacture and can develop under typical operating conditions, on products that use such materials. Conformal coatings applied over top of a whisker-prone surface will not prevent the formation of tin whiskers. Alloys of 3 percent lead, by mass, have shown to inhibit the growth of tin whiskers (see 3.2.4). For additional information on this matter, refer to ASTM-B545 (Standard Specification for Electrodeposited Coatings of Tin).

6.9 Environmentally preferable material. Environmentally preferable materials should be used to the maximum extent possible to meet the requirements of this specification. As of the dating of this document, the U.S. Environmental Protection Agency (EPA) is focusing efforts on reducing 31 priority chemicals. The list of chemicals is available on their website at <http://www.epa.gov/epaoswer/hazwaste/minimize/chemlist.htm>. Further information is available at the following EPA site: <http://www.epa.gov/epaoswer/hazwaste/minimize/>. Included in the EPA list of 31 priority chemicals are cadmium, lead, and mercury. Use of the materials on the list should be minimized or eliminated unless needed to meet the requirements specified herein (see Section 3).

6.10 Changes from previous issue. Marginal notations are not used in this revision to identify changes with respect to the previous issue due to the extensiveness of the changes.

Custodians:  
Army - AT  
DLA - CC

Preparing activity:  
DLA - CC

(Project 5963-2007-002)

NOTE: The activities listed above were interested in this document as of the date of this document. Since organizations and responsibilities can change, you should verify the currency of the information above using the ASSIST Online database at <http://assist.daps.dla.mil/>.